

Project _____

Type _____

Notes _____

PERFORMANCE PER LINEAR FOOT AT 3500K

NOMINAL LUMEN OUTPUT	INPUT WATTS*	EFFICACY
500 lm/ft	4.54 W/ft	110 lm/W
600 lm/ft	5.48 W/ft	111 lm/W
800 lm/ft	7.2 W/ft	110 lm/W
1000 lm/ft	9 W/ft	111 lm/W

Please consult factory for custom lumen output and wattage.



Ordering Guide

MBWLED		NOM. LUMENS/FT		CRI		COLOUR TEMP. (choose one)			SHIELDING	LENGTH/FT	FINISH			
MBWLED	MINI BOX	500	500 lm/ft - Min	80	80 CRI	27	2700 K	TW2750	2700-5000 K - Tunable White	S	2	2'	AP	aluminum paint
	Wall LED	1000	1000 lm/ft - Max	90	90 CRI*	30	3000 K	TW2765	2700-6500 K - Tunable White		3	3'	W	white
						35	3500 K	BTW3527	3500-2700 K - Tunable BIOS		4	4'	BLK	black
						40	4000 K	BTW4027	4000-2700 K - Tunable BIOS		6	6'	C	custom
						B30	3000 K - BIOS*				8	8'		
						B35	3500 K - BIOS*				12	12'		
						B40	4000 K - BIOS*				S(L)	system run		
Outputs between listed min and max are available. Consult factory for outputs outside of the listed range. Consult factory for max output with BIOS				* Not available with BIOS.		Consult Axitune technical sheet for more information on color technology. Consult BIOS guide for more information on BIOS technology.				1' increment, minimum 2'				

VOLTAGE		DRIVER		CIRCUITS		BATTERY (OPTIONAL)		IC CONTROLS (OPTIONAL)	
120	120 V	DP	dimming (0-10V) 1%	1	1 circuit	B(#)	battery pack 4' sections	DS(#)	daylight sensor
277	277 V	LT(#)	Lutron*	2	2 circuits			OS(#)	occupancy sensor
347	347 V	BI	bi-level dimming	+E(#)	emergency circuit *			DOS(#)	daylight & occupancy sensor
UNV	universal	O(#)	other**	+NL(#)	night light circuit *			EN(#)	Enlighted integral *
DC	low voltage*	DPB(STC)	dimming (0-10V) 1% with BIOS*	+GTD(#)	generator transfer device *			ENR(#)	Enlighted remote **
		DPB(DYN)	Bio-dimming™ 100%-81% with BIOS*					WC(#)	wireless control dimming
		TW(#)	tunable white drivers*						
		POE(#)	POE drivers*						
* Only available with POE drivers.		* See page 2 to specify system ** Please consult factory; see page 2		* Specify quantity		Specify quantity Please consult factory Not available with 347V		* For flush option only; Please consult factory ** Please consult factory Specify quantity. Requires 8" blank See integrated controls guide for more details. Consult factory for Tunable White. Not available with DPB (DYN) driver for BIOS with Dynamic Spectrum.	

CUSTOM (OPTIONAL)	
C	custom
Please specify	

ELECTRICAL

Lutron driver*	LDE1 - Hi-lume 1% EcoSystem with Soft-on, Fade-to Black LTEA - Hi-lume 1% 2-wire (120V forward phase only) <small>*Consult factory</small>
Other drivers**	DALI - Digital Addressable Lighting Interface DMX - Digital Multiplex Xitanium SR - For wireless sensor
BIOS DPB drivers*	STC - BIOS control 0-10V with static spectrum and BIC SkyBlue enabled from 100% to 1%. DYN - BIOS control 0-10V with dynamic spectrum and BIOS SkyBlue® with Bio-Dimming™, which changes spectral qualities by removing the SkyBlue component when dimming from 100% to 81%, while light output remains relatively constant; bio-dimming reduces CCT 2700K. Dimming from 80% to 1% will then reduce light output.
Tunable White TW drivers*	DALIDT6 - DALI Type 6 (Two DALI Addresses) DALIDT8 - DALI Type 8 (One DALI Address) LTTW - Lutron T-Series Tunable White
Power over Ethernet POE drivers* <small>UL2108 certified for integral or remote driver</small>	MOLEX IGOR SMARTENGINE O - Other (Consult factory)
Emergency	Integral emergency battery pack or emergency circuit optional.
Input Voltage	120V, 277V, 347V, UNV, DC.
Flex Whip	Shipped in a separate box for contractors to install

*Choose driver from available options.

i Incorporating these components may have limitations or affect the length of the luminaire. Please contact factory for more details.

LED SYSTEM

CRI	Minimum 80 or 90 color rendering index.
CRI BIOS	Minimum 80 color rendering index with R9>75 for all CCTs.
CCT Single Color	Choice of 2700K, 3000K, 3500K and 4000K color temperature with a great color consistency (within 3-step MacAdam ellipse). Both within fixture and fixture to fixture.
CCT BIOS	BIOS Static (STC) Choice of 3000K, 3500K and 4000K. BIOS SkyBlue® Dynamic (DYN) Choice of 3000K, 3500K, and 4000K with Bio-Dimming™ BIOS Tunable White (BTW) Choice of 4000-2700K and 3500-2700K; does not use a bio-dimmer, it uses TW drivers, which allow independent control of CCT and intensity; e.g., BTW4027 provides combined SkyBlue + white light at 4000K, SkyBlue is removed at 2700K. Light output can be adjusted for each CCT. Consult BIOS guide for more information on BIOS technology.
CCT Axitune Systems	Consult Axitune technical sheet for more information on color technology.
LED life	Minimum 50,000h with 85% of lumen maintenance in 25°C ambient temperature, in compliance with IES LM-80 testing measurements.
Thermal Management	Aluminum housing acting as the heat sink to maximize life.
Environment	Dry and damp rated in operating ambient temperatures of 0-40°C (32-104F).

● **LIGHT DISTRIBUTION**



semi direct

● **MOUNTING SPACING**

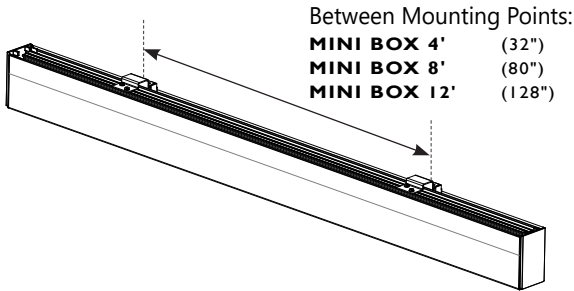

● **MOUNTING OPTIONS**

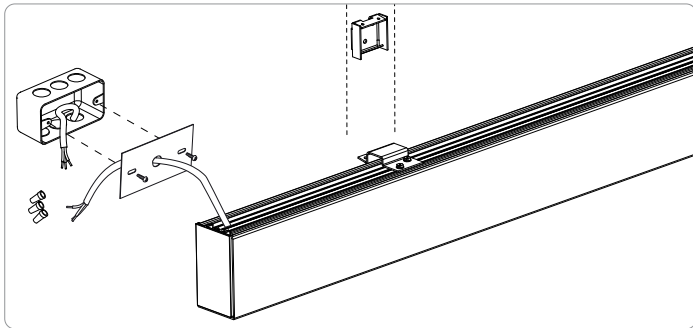

MOUNTING POINT

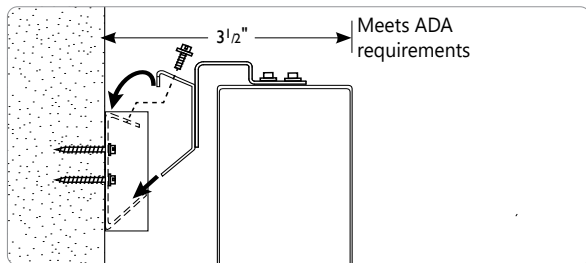

SIDE DETAIL

● Installation sheets for all mounting options are available at www.axislighting.com

● **SYSTEMS (S#)**

Runs of MINI BOX that are greater than 12ft in length are designated as systems (S#). This means that the run is comprised of a combination of sections to be assembled on site using our joining system. The run is comprised of a combination of sections to be assembled on site using our joining system, maximum 4' lens with joining end cap. For more information on systems and joining, please refer to the MINI BOX installation sheets available for download at www.axislighting.com

● **OTHER MOUNTING OPTIONS**

MINI BOX is also available in pendant and surface mounted options.

● Specification sheets for all mounting options are available for download at www.axislighting.com

● **WEIGHT**

MINI BOX Wall 4 ft	8.4 lbs / 3.9 Kg
MINI BOX Wall 8 ft	16.8 lbs / 7.7 Kg
MINI BOX Wall 12 ft	25.2 lbs / 11.6 Kg

● **OPTICS OPTIONS**

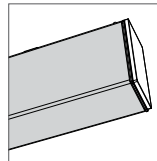

S satin lens

● **FINISH**

Powder coated and custom finishes are also available.

● **APPROVALS**

Certified to UL and CSA standards
 Meets ADA requirements.
 Suitable for damp locations.



● PHOTOMETRIC DATA

500 lm/ft

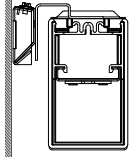

PHOTOMETRIC CURVE

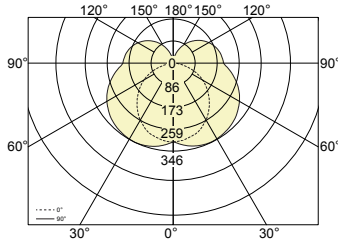

Lumen/ft down: 500 lm/ft
Total Lumens: 2000 lm (for 4ft)
Input Watts: 18.16 W
Efficacy: 110 lm/W
 IES FILE: MBWLED-500-80-35-S-4.IES

TESTED ACCORDING TO IES LM-79-2008

CANDELA DISTRIBUTION

Vertical Angle	Horizontal Angles				
	0	22.5	45	67.5	90
0	311	311	311	311	311
5	309	314	317	320	323
15	297	313	325	335	339
25	274	299	323	339	346
35	241	276	309	333	342
45	202	245	289	320	331
55	157	208	262	300	312
65	108	166	228	272	286
75	59	123	190	237	252
85	16	82	151	198	214
90	1	66	134	183	198
95	1	65	132	179	194
105	1	62	126	171	185
115	0	57	116	157	170
125	0	49	102	138	150
135	0	39	82	115	125
145	0	28	59	90	97
155	0	20	40	56	67
165	0	9	21	28	37
175	0	2	4	6	2
180	0	0	0	0	0

ZONAL LUMENS

Zone	Lumens
0	
0-10	30
10-20	91
20-30	147
30-40	190
40-50	216
50-60	225
60-70	214
70-80	187
80-90	150
90-100	129
100-110	119
110-120	103
120-130	82
130-140	58
140-150	36
150-160	17
160-170	6
170-180	1

LUMINANCE DATA (cd/m²)

Vertical Angle	Horizontal Angles		
	0	45	90
45	4196	4616	4863
55	3999	4662	4994
65	3671	4751	5209
75	3197	4954	5494
85	2305	5456	6062

600 lm/ft

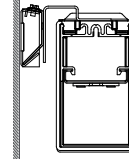

PHOTOMETRIC CURVE

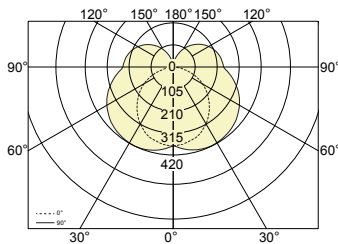

Lumen/ft down: 600 lm/ft
Total Lumens: 2430 lm (for 4ft)
Input Watts: 21.8 W
Efficacy: 111 lm/W
 IES FILE: MBWLED-600-80-35-S-4.IES

TESTED ACCORDING TO IES LM-79-2008

CANDELA DISTRIBUTION

Vertical Angle	Horizontal Angles				
	0	22.5	45	67.5	90
0	378	378	378	378	378
5	375	381	385	389	392
15	361	380	395	407	412
25	333	363	392	412	420
35	293	335	376	405	415
45	245	298	351	389	402
55	191	253	318	364	379
65	131	202	277	331	348
75	72	150	231	288	306
85	20	100	183	241	260
90	1	80	163	222	240
95	1	79	160	218	236
105	1	75	153	208	225
115	0	69	141	191	207
125	0	60	124	168	182
135	0	47	100	140	152
145	0	34	72	109	118
155	0	24	48	68	82
165	0	11	26	34	45
175	0	2	5	7	3
180	0	0	0	0	0

ZONAL LUMENS

Zone	Lumens
0	
0-10	37
10-20	111
20-30	178
30-40	230
40-50	263
50-60	273
60-70	260
70-80	227
80-90	182
90-100	157
100-110	145
110-120	125
120-130	99
130-140	71
140-150	43
150-160	21
160-170	7
170-180	1

LUMINANCE DATA (cd/m²)

Vertical Angle	Horizontal Angles		
	0	45	90
45	5099	5609	5908
55	4859	5665	6067
65	4461	5772	6329
75	3884	6019	6675
85	2801	6629	7365

i All IES files are available for download at: www.axislighting.com

● **PHOTOMETRIC DATA**

800 lm/ft

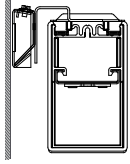

PHOTOMETRIC CURVE

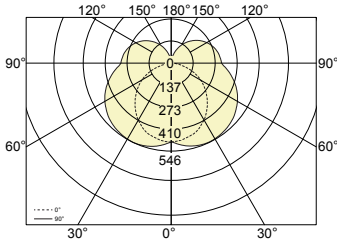

Lumen/ft down: 800 lm/ft
Total Lumens: 3159 lm (for 4ft)
Input Watts: 28.8 W
Efficacy: 110 lm/W
 IES FILE: MBWLED-800-80-35-S-4.IES

TESTED ACCORDING TO IES LM-79-2008

CANDELA DISTRIBUTION

Vertical Angle	Horizontal Angles				
	0	22.5	45	67.5	90
0	491	491	491	491	491
5	488	495	501	506	510
15	469	494	514	529	536
25	433	472	510	536	546
35	381	436	489	527	540
45	319	387	456	506	523
55	248	329	413	473	493
65	170	263	360	430	452
75	94	195	300	374	398
85	26	130	238	313	338
90	1	104	212	289	312
95	1	103	208	283	307
105	1	98	199	270	293
115	0	90	183	248	269
125	0	78	161	218	237
135	0	61	130	182	198
145	0	44	94	142	153
155	0	31	62	88	107
165	0	14	34	44	59
175	0	3	7	9	4
180	0	0	0	0	0

ZONAL LUMENS

Zone	Lumens
0	
0-10	48
10-20	144
20-30	232
30-40	299
40-50	342
50-60	355
60-70	338
70-80	295
80-90	236
90-100	204
100-110	189
110-120	163
120-130	129
130-140	92
140-150	56
150-160	28
160-170	9
170-180	1

LUMINANCE DATA (cd/m²)

Vertical Angle	Horizontal Angles		
	0	45	90
45	6628	7292	7681
55	6317	7365	7888
65	5799	7504	8228
75	5050	7825	8678
85	3642	8618	9575

1000 lm/ft

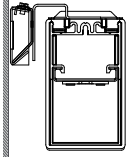

PHOTOMETRIC CURVE

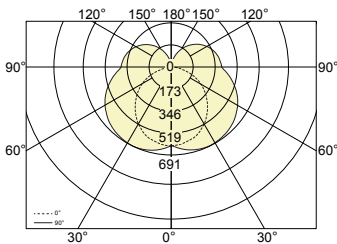

Lumen/ft down: 1000 lm/ft
Total Lumens: 4000 lm (for 4ft)
Input Watts: 36 W
Efficacy: 111 lm/W
 IES FILE: MBWLED-1000-80-35-S-4.IES

TESTED ACCORDING TO IES LM-79-2008

CANDELA DISTRIBUTION

Vertical Angle	Horizontal Angles				
	0	22.5	45	67.5	90
0	622	622	622	622	622
5	617	627	634	640	645
15	594	626	650	670	678
25	548	598	645	678	691
35	482	551	619	667	683
45	403	491	578	640	662
55	314	416	523	599	624
65	216	333	456	545	573
75	119	247	380	474	504
85	33	165	301	397	428
90	2	132	268	365	395
95	2	130	263	359	388
105	2	123	252	342	370
115	0	114	232	314	341
125	0	99	204	277	300
135	0	77	165	230	250
145	0	56	119	179	194
155	0	40	79	112	135
165	0	18	43	56	74
175	0	3	8	12	5
180	0	0	0	0	0

ZONAL LUMENS

Zone	Lumens
0	
0-10	61
10-20	183
20-30	293
30-40	379
40-50	433
50-60	449
60-70	428
70-80	373
80-90	300
90-100	258
100-110	239
110-120	206
120-130	163
130-140	116
140-150	71
150-160	35
160-170	11
170-180	1

LUMINANCE DATA (cd/m²)

Vertical Angle	Horizontal Angles		
	0	45	90
45	8393	9233	9725
55	7999	9325	9988
65	7343	9502	10418
75	6394	9908	10988
85	4611	10912	12124

i All IES files are available for download at: www.axislighting.com