

Project \_\_\_\_\_

Type \_\_\_\_\_

Notes \_\_\_\_\_

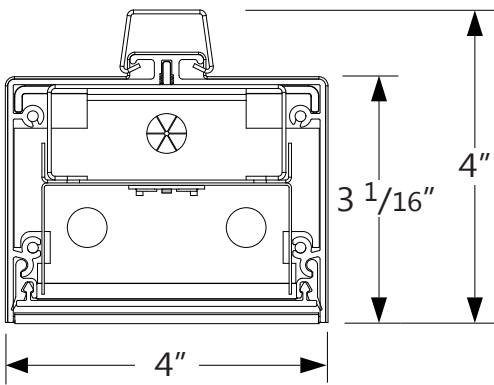

**PERFORMANCE PER LINEAR FOOT AT 3500K**

NOMINAL LUMEN OUTPUT	INPUT WATTS*	EFFICACY
1000 lm/ft	11.5 W/ft	87 lm/W

Please consult factory for custom lumen output and wattage.



cULus Listed  
Type I.C.



**Ordering Guide**

WBSLED		NOM.LUMENS/FT		CRI		COLOR TEMP.		S		LENGTH (FT)	
PRODUCT ID		400	1000	80	90	27	30	35	40	S	
Surface LED		400 lm/ft - Min.	1000 lm/ft - Max.	80 CRI	90 CRI	2700 K	3000 K	3500 K	4000 K	S satin lens	2 2'
											3 3'
											4 4'
											5 5'
											8 8'
											S# system run
Outputs between listed min and max are available. Consult factory for outputs outside of the listed range.										Nominal lit length not including end caps	

FINISH		VOLTAGE		DRIVER		CIRCUITS		MOUNTING/SUSPENSION	
AP	aluminum paint	120	120 V	DP	dimming (0-10V) 1%	1	1 circuit	SC	surface solid ceiling
W	white	277	277 V	LT(#)	Lutron *	2	2 circuits		
BLK	black	347	347 V	BI	bi-level dimming	+E(#)	emergency circuit *		
C	custom	UNV	universal	O(#)	other **	+NL(#)	night light circuit *		
		DC	low voltage*	POE(#)	POE drivers*	+GTD(#)	generator transfer device *		
		* Only available with POE drivers.		*Operating up to -20°C; Specify system ** Please consult factory; see page 2		* Specify quantity			

BATTERY (OPTIONAL)		OTHER (OPTIONAL)		IC CONTROLS (OPTIONAL)		CUSTOM (OPTIONAL)	
B#	battery pack (integral)	+EF	end feed*	OS(#)	occupancy sensor	C	custom
		+N	natatorium finish	EN(#)	Enlighted integral		
				WC(#)	wireless control dimming		
Not available with 347V Please consult factory		* See page 2 for more details.		<a href="#">See integrated controls guide for further details</a> Please consult factory		Please specify	

● **MOUNTING OPTIONS**

**SC SURFACE SOLID CEILING**

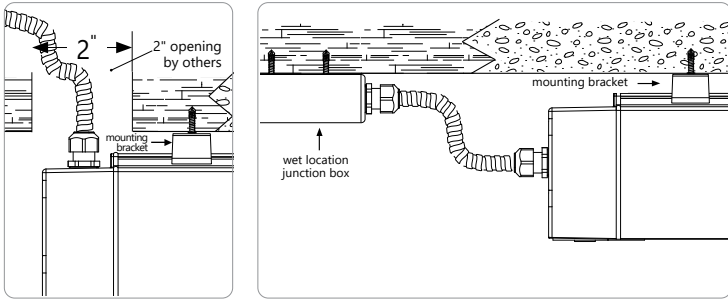

Power top feed

Power end feed

● **OTHER MOUNTING OPTIONS**

WET BEAM 4 LED is available with recessed horizontal, recessed vertical, pendant, and wall mounted options.

● **CONSTRUCTION**

<b>Housing</b>	Extruded Aluminum (0.062" nominal) Up to 70% Recycled Content
<b>End Cap</b>	Die Cast Zinc (0.070" nominal)
<b>Interior Brackets</b>	Die Formed Sheet Steel (16 gauge)
<b>Gaskets</b>	Moulded Elastomer (0.100" nominal)
<b>Lens Gaskets</b>	Extruded Elastomer (0.045" nominal)
<b>Satin Lens</b>	Extruded Polycarbonate

● **ELECTRICAL**

<b>Lutron driver</b>	LDE1 - Hi-lume 1% EcoSystem with Soft-on, Fade-to-Black
<b>Other drivers**</b>	DALI - Digital Addressable Lighting Interface DMX - Digital Multiplex Xitanium SR - For wireless sensor
<b>Power over Ethernet POE drivers*</b>	MOLEX IGOR SMARTENGINE O - Other (Consult factory)
<b>Emergency</b>	Integral emergency battery pack or emergency circuit optional.
<b>Input Voltage</b>	120V, 277V, 347V, UNV.

**i** Incorporating these components may have limitations or affect the length of the luminaire. Please contact factory for more details.

● **LED SYSTEM**

<b>CRI</b>	Minimum 80 or 90 color rendering index.
<b>CCT</b>	Choice of 2700K, 3000K, 3500K and 4000K color temperature with a great color consistency (within 3-step MacAdam ellipse). Both within fixture and fixture to fixture.
<b>LED life</b>	Minimum 50,000h with 85% of lumen maintenance in 25°C ambient temperature, in compliance with IES LM-80 testing measurements.
<b>Thermal Management</b>	Aluminum housing acting as the heat sink to maximize life.

**i** Row configuration, specification sheets and mounting spacing guides are available for download at: [www.axislighting.com](http://www.axislighting.com)

● **OPTICS**

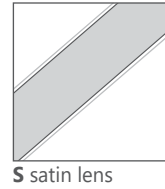

**SATIN LENS**  
Extruded Polycarbonate

S satin lens

● **WEIGHT**

<b>Surface 4 ft</b>	12.8 lbs / 5.8 kg
<b>Surface 8 ft</b>	24.5 lbs / 11.1 kg

● **GASKETTED FIXTURE**

With its gasketed end cap and lens the Wet BEAM 4 LED is made for wet locations, and is ideal for exterior soffits and canopies of malls, hospitals and other institutions.

● **JOINER SYSTEM**

Wet BEAM 4 modular system consists of smaller modules joined and gasketed together allowing for system runs in lengths of 4' and 8' as well as custom lengths up to 12'.

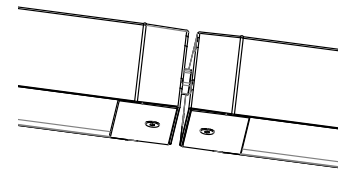

\* For continuous rows allow 2" for connectors between each fixture.

● **POWER FEED**

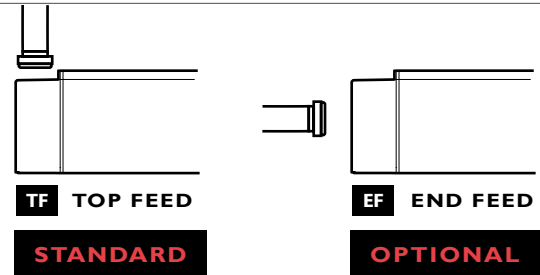

\* Not available with 347 V.

● **FINISH**

Powder coated and custom finishes are also available.

● **APPROVALS**

Certified wet locations to UL and CSA standards

● **WARRANTY**

Axis Lighting will warrant defective LEDs, boards, and drivers for 5 years from date of purchase. Warranty is valid if luminaire is installed and used according to specifications. If defective, Axis will send replacement boards or drivers at no cost along with detailed replacement instructions and instructions on how to return defective components to Axis.

● PHOTOMETRIC DATA

1000 lm/ft

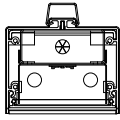

PHOTOMETRIC CURVE

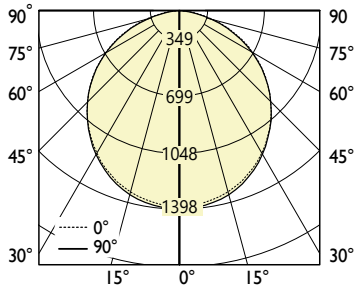

**Luminaire Lumens: 1000 lm/ft**  
**Total Lumens: 4000 lm (for 4ft)**  
**Input Watts: 45.8 W/ft**  
**Efficacy: 87 lm/W**  
 IES FILE: WBSLED-1000-80-35-S-4.IES

TESTED ACCORDING TO IES LM-79-2008

CANDELA DISTRIBUTION

Vertical Angle	Horizontal Angles				
	0	22.5	45	67.5	90
0	1397	1397	1397	1397	1397
5	1393	1391	1391	1389	1390
15	1347	1344	1341	1339	1338
25	1256	1250	1246	1243	1242
35	1123	1115	1109	1104	1104
45	952	943	935	929	928
55	748	738	729	720	718
65	514	503	492	482	479
75	272	262	249	236	233
85	57	49	39	30	27
90	4	3	3	3	3

ZONAL LUMENS

Zone	Lumens
0	
0-10	132
10-20	380
20-30	577
30-40	699
40-50	728
50-60	659
60-70	496
70-80	271
80-90	58
90	

LUMINANCE DATA (cd/m<sup>2</sup>)

Vertical Angle	Horizontal Angles		
	0	45	90
45	10617	10430	10350
55	10276	10017	9870
65	9587	9183	8941
75	8298	7599	7091
85	5172	3533	2411

**i** All IES files are available for download at: [www.axislighting.com](http://www.axislighting.com)